

Article number: 20165B402SW

Description: E+G

Base plate clamp GN165-B40-2-SW

## Measures

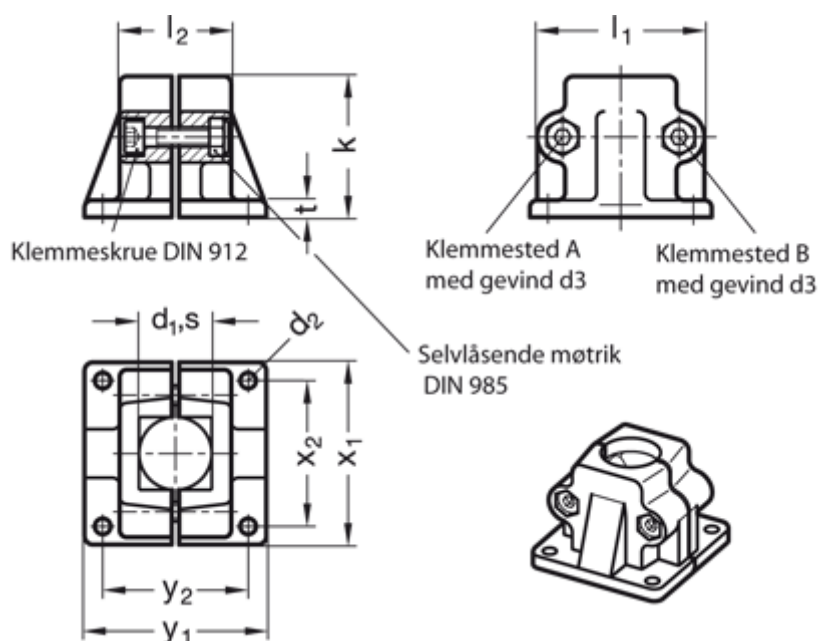

Adjustable clamp lever = GN 911-M10-63 have to be ordered separately

d1	= B42
d2	= 11
d3	= M10
k	= 91
l1	= 98
l2	= 70
t	= 14

x1 = 115
x2 = 90
y1 = 119
y2 = 90